

INDUSTRIAL CONCRETE PAVERS

- Designed for easy installation and maintenance.
- Applications: heavy-duty paved areas like port yards and container yards.
- Compressive strength: 6,000 - 8,000 psi

SIZES	Length mm	Width mm	Height mm
	200	100	100
	200	100	120
	200	100	150

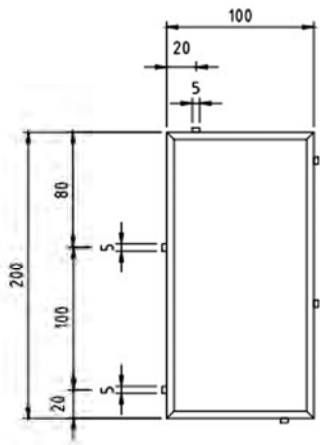

PLAN

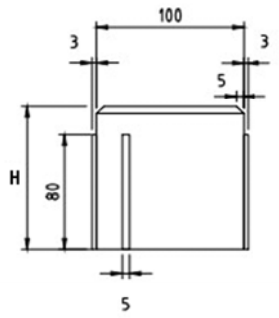

ELEVATION

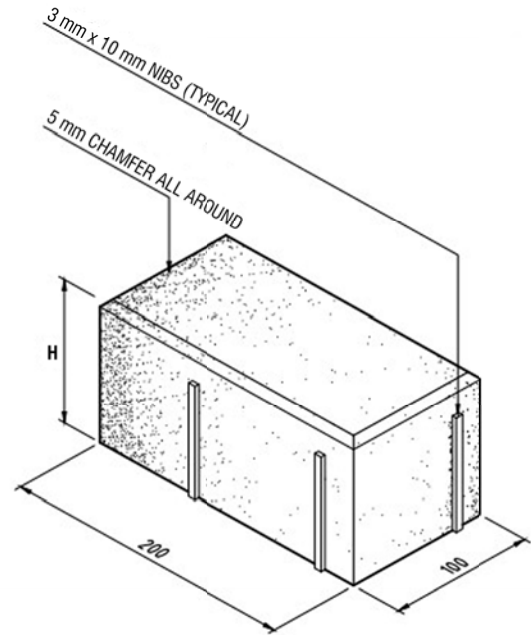

ISOMETRIC VIEW

LAYOUT PATTERNS

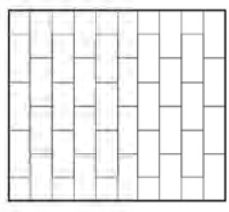

RUNNING BOND VERTICAL

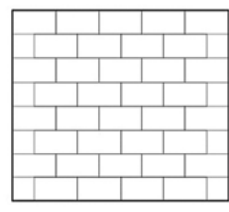

RUNNING BOND HORIZONTAL

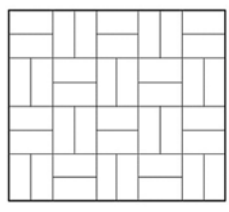

BASKET WEAVE

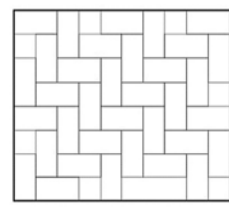

HERRINGBONE 90

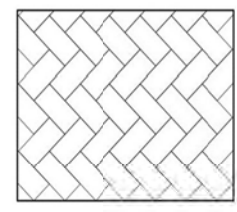

HERRINGBONE 45

- Jackbilt paving blocks meet specifications of ASTM C90-75 and the Product Standard Agency (PSA).
- Blocks have a +/- 3 mm tolerance for all dimensions as permitted by ASTM standards for masonry blocks.

STRONGER • FASTER • BETTER